

Passive PM FBT Coupler, 2x2, 50:50 1310nm, 1M 250um bare fiber

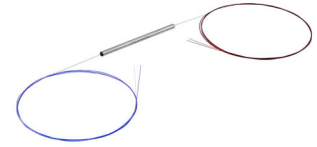

PPMF-225031-12N

Features

- Polarized Maintaining
- Fused Bionic Taper
- 2X2 , 50:50
- 1M, without connectors
- Low Insertion Loss
- High Extinction Ratio
- High Isolation

Applications

- Optical Amplifier
- Communication Networks
- Fiber Sensors
- Coherent Dedection
- Research and Development
- Power Monitoring

Description

The L-com PPMF-225031-12N is a Polarized Maintaining Fused Bionic Taper coupler. The leads are 2x2 with a coupling ratio of 50:50. The wavelength is 1310nm with a cabling of 250um bare fiber, without connectors . The L-com PPMF-225031-12N features a packaging of 3X54mm and fiber length of 1M. The L-com PPMF-225031-12N is one of thousands of fiber optic products in stock and ready to ship. Contact our knowledgeable technical support and sales staff with your questions on fiber optic connectivity or other L-com products.

Configuration

Module Function	Coupler
Filter Type	FBT
Fiber Type	Panda PM 250um Bare
Fiber Diameter	250um
Package	3x54mm

Filter Specifications

Description	Minimum	Typical	Maximum	Units
Operating Wavelength	1310			nm
Operating Bandwidth		20		nm
Extinction Ratio	20			dB
Return Loss	50			dB
Directivity	55			dB

Click the following link (or enter part number in "SEARCH" on website) to obtain additional part information including price, inventory and certifications:
[Passive PM FBT Coupler, 2x2, 50:50 1310nm, 1M 250um bare fiber PPMF-225031-12N](#)

Passive PM FBT Coupler, 2x2, 50:50 1310nm, 1M 250um bare fiber

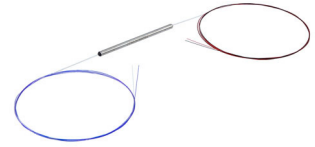

PPMF-225031-12N

Mini Size: Φ 3x54mm 1x2 or 2x2 Coupler

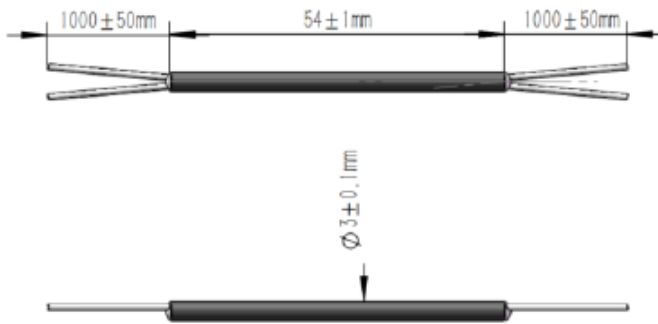

1x2/2x2 900um loose tube optical coupler with Connector

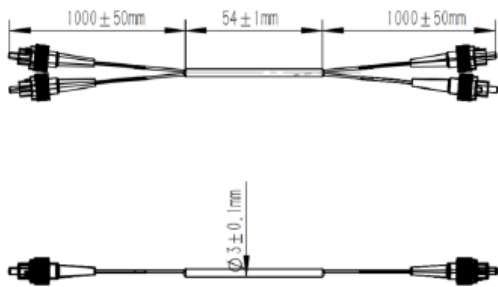
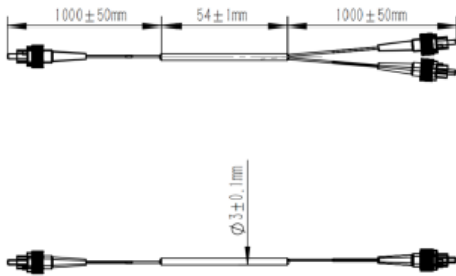

Size
Length

2.13 in [54.1 mm]

Passive PM FBT Coupler, 2x2, 50:50 1310nm, 1M 250um bare fiber

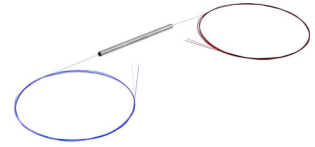

PPMF-225031-12N

Weight	0.25 lbs [113.4 g]
--------	--------------------

Environmental Specifications

Temperature

Operating Range	-5 to +75 deg C
Storage Range	-40 to +85 deg C

Compliance Certifications (see [product page](#) for current document)

Plotted and Other Data

Notes:

Passive PM FBT Coupler, 2x2, 50:50 1310nm, 1M 250um bare fiber from L-com has same day shipment for domestic and International orders. Our portfolio includes coaxial cable assemblies, connectors, adapters and custom products as well as lightning and surge protectors, NEMA rated enclosures, and an RF product line which includes antennas, amplifiers, passive, and active components.

The information contained within this document is accurate to the best of our knowledge and representative of the part described herein. It may be necessary to make modifications to the part and/or the documentation of the part in order to impliment improvements. L-com reserves the right to make such changes as required. Unless otherwise stated, all specifications are nominal. L-com does not make any representation or warranty regarding the suitability of the part described herein for any particular purpose, and L-com does not assume liability arising out of the use of any part or document.

PPMF-225031-12N CAD Drawing

