

THE INFORMATION CONTAINED IN THIS DRAWING IS THE SOLE PROPERTY OF L-COM, INC. ANY REPRODUCTION IN PART OR WHOLE WITHOUT THE WRITTEN PERMISSION OF L-COM, INC. IS PROHIBITED.

REVISIONS			
REV	DESCRIPTION	DATE	APPROVED
A	INITIAL RELEASE	05/20/2021	PHOSPODAR

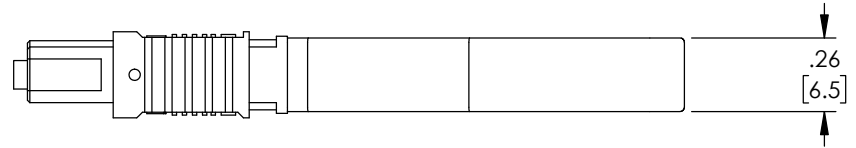
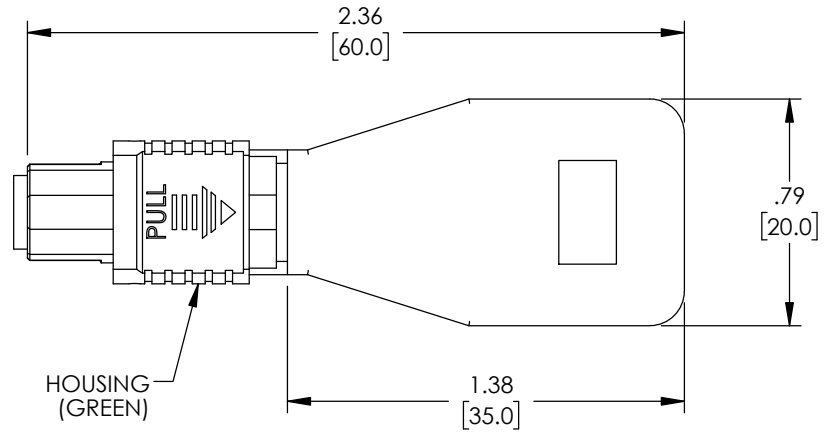
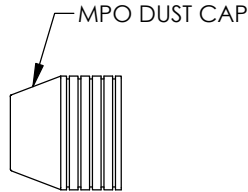
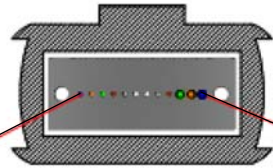

CHANNEL	1	2	3	4	5	6
FIBER COLOR	BLUE	ORANGE	GREEN	BROWN	GRAY	WHITE

7	8	9	10	11	12	CHANNEL
WHITE	GRAY	BROWN	GREEN	ORANGE	BLUE	FIBER COLOR

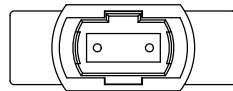

MODEL NUMBER	ATTENUATION
FOL-AT-MPF12SM-01D	1dB
FOL-AT-MPF12SM-02D	2dB
FOL-AT-MPF12SM-03D	3dB
FOL-AT-MPF12SM-04D	4dB
FOL-AT-MPF12SM-05D	5dB
FOL-AT-MPF12SM-07D	7dB
FOL-AT-MPF12SM-10D	10dB

SPECIFICATIONS:

INSERTION LOSS: ≤ 0.7 dB
 RETURN LOSS: ≥ 50 dB
 TEST WAVELENGTH: 1310 nm

NOTES:

1. ALL DIMENSIONS ARE FOR REFERENCE ONLY.
2. MPO CONNECTOR ASSEMBLY POLISH TYPE: PC
3. ALL CONNECTORS ACCOMPANIED WITH A DUST CAP, INSTALLED.
4. CABLE ASSEMBLY SHALL BE INDIVIDUALLY PACKAGED IN ACCORDANCE WITH L-COM SPECIFICATION PS-0031.

REGULATORY COMPLIANCE:

EU RoHS DIRECTIVE (MOST RECENT RELEASED VERSION)

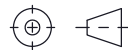
UNLESS OTHERWISE SPECIFIED, DIMENSIONS ARE IN INCHES [mm] OVERALL CABLE LENGTH TOLERANCE: ≤12 [305] = +1 [25] / -0 >12 [305] ≤60 [1524] = +2 [51] / -0 >60 [1524] ≤120 [3048] = +4 [102] / -0 >120 [3048] ≤300 [7620] = +6 [152] / -0 >300 [7620] = +5% / -0 ALL OTHER DIMENSIONAL TOLERANCES: .X = ± .2 [5] FRACTIONS ± 1/32 .XX = ± .02 [5] ANGLES ± 1° .XXX = ± .005 [13]	APPROVALS	DATE	 50 High Street, West Mill, North Andover, MA 01845 USA. Phone: 1.800.341.5266 1.978.682.6936
	DRAWN BY DFRISIELLO	05/20/2021	
THIRD-ANGLE PROJECTION 	CHECKED BY PHOSPODAR	05/20/2021	CATEGORY FIBER OPTICS
	APPROVED BY PHOSPODAR	05/20/2021	PRODUCT DESCRIPTION Fiber Loopback MPO Female Single Mode
	CONFIGURATION DETAILS OF UNDIMENSIONED FEATURES MAY VARY		
	COLOR VARIATIONS MAY OCCUR		
	SIZE A	CAGE CODE 43321	ITEM NO. FOL-AT-MPF12SM
	SCALE: NONE	CAD FILE: FOL-AT-MPF12SM.SLDDRW	SHEET 1 OF 1